

MONITORING SCREEN

FOR ROVER ELITE SERIES



Version 1.1



Important Safety Instructions

Please save these instructions.

This manual contains important installation and operation instructions for the monitoring screen. Please observe these instructions and keep them located near the monitoring screen for further reference. The following symbols are used throughout the manual to indicate potentially dangerous conditions or important safety information.

WARNING

Indicates a potentially dangerous condition. Use extreme caution when performing this task.

CAUTION

Indicates a critical procedure for the safe and proper installation and operation of the monitoring screen.

NOTE

Indicates a procedure or function that is important to the safe and proper installation and operation of the monitoring screen.

■ **Disclaimer**

The manufacturer accepts no liability for any damage caused by:

- Force majeure including fire, typhoon, flood, earthquake, war, and terrorism.
- Intentional or accidental misuse, abuse, neglect or improper maintenance, and use under abnormal conditions.
- Improper installation, improper operation, and malfunction of a peripheral device.
- Contamination with hazardous substances, diseases, vermin, or radiation.
- Alterations to the product without express written consent from the manufacturer.
- must be properly ventilated to ensure no build-up of explosive gases prior to installation

■ General Safety Information

- Read all of the instructions and cautions in the manual before beginning the installation.
- There are no serviceable parts for this controller. Do **NOT** disassemble or attempt to repair the controller.
- Do **NOT** allow water to enter the controller.
- Make sure all connections going into and from the controller are tight.

■ Charge Controller Safety

- **NEVER** connect the solar panel array to the controller without a battery. Battery must be connected first.
- Ensure input voltage does not exceed 100 VDC to prevent permanent damage. Use the Open Circuit Voltage (Voc) to make sure the voltage does not exceed this value when connecting panels together.

CAUTION

- The monitoring screen is designed for indoor/compartment installation. DO NOT expose it to direct sunlight, rain, snow, moisture, or liquids of any type.
- DO NOT puncture, drop, crush, burn, penetrate, or strike the monitoring screen.
- DO NOT open, dismantle, or modify the monitoring screen.
- The monitoring Screen is only compatible with Renogy Elite Series charge controllers. DO NOT attempt connecting the monitoring screen to other charge controllers or systems.

Table of Contents

Important Safety Instructions	01
General Information	04
Product Overview	05
Identification of Parts	05
Dimensions	06
Installation	07
Operation	12
LCD interface	12
Navigating through Screens	13
LCD Indicators	14
Programming Battery Type	15
Selecting Lithium	17
Lithium Battery Activation	18
Troubleshooting	19
Technical Specifications	24

General Information

The RMS-RVRE is a high precision meter designed for Rover Elite charge controllers. Featuring a backlit display and flush-mountable, it is engineered for an aesthetically clean and professional look on RVs or camper walls. Utilize the 4-key input to easily navigate through your system information or modify quick parameters as well as identify any error codes. The RMS-RVRE is the perfect monitor companion to optimize any solar system!

Key Features

- **Plug and Play**
Simply connect the monitoring screen to the charge controller using an RJ45 communication cable for real-time monitoring.
- **Accurate Readings**
Obtains charge controller status directly from the Rover Elite for precise tracking and monitoring.
- **Comprehensive Protection**
Displays straightforward warning codes for quick recognition of potential abnormal conditions and improper operation.
- **Easy Operation**
Shows detailed system information at the push of a button without the need of system configuration and calibration.

Product Overview

■ Identification of Parts

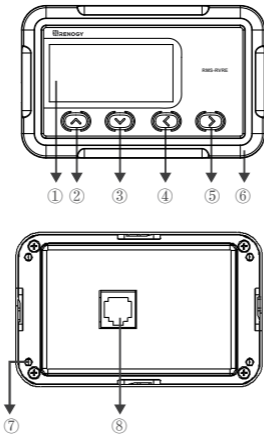

- | | |
|------------------------|----------------------------|
| ① LCD Screen | ⑤ Parameter Setting Button |
| ② Page Forward Button | ⑥ Front Cover Plate |
| ③ Page Backward Button | ⑦ Mounting Holes Locations |
| ④ Previous Page Button | ⑧ RJ45 Communication Port |

Dimensions

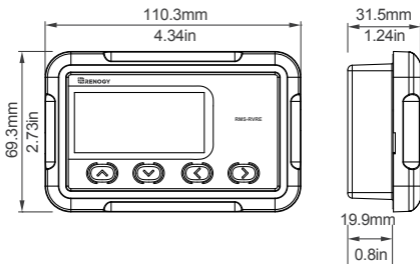

■ Additional Components

- RJ45 Communication Cable

The RJ45 Communication Cable (5m/16.4ft) is used to connect the monitoring screen to the charge controller for power supply and data transmission.

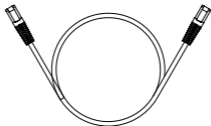

- Self-tapping Screws (4)

The Self-tapping Screws (M2.9x13) are used affix the monitoring screen on the mounting surface.



Installation

WARNING

BEFORE drilling, make sure there are no electrical component or other obstacles that may interfere with installation on the other side of the mounting surface.

CAUTION

Before installation, check to make sure the power is working properly. Resolve any issues before installation of monitoring screen and cable.

The RMS-RVRE requires a flush mount installation. The RMS-RVRE's faceplate will be flush with the mounting surface and the body of the meter.

■ Preparation

Before the installation of the monitoring screen, it is recommended to have the following tools available:

- Pencil
- Drill
- Jigsaw
- Phillips screwdriver

■ Choosing an Installation Location

NOTE

The following are recommendations for installation. There will be multiple mounting methods depending on users' applications.

Please choose a clean, dry, protected and easily accessible indoor location to install the monitoring screen. It is recommended to mount the monitoring screen at eye level for easy access to the battery information and operation buttons. The RJ45 Communication Port on the monitoring screen is accessible from the back of the unit. Clearance of at least 2 inches (50 mm) behind the unit is recommended to allow for the bending radius of the RJ45 Communication Cable that connects to the monitoring screen.

■ Mounting the Monitoring Screen

1. Remove the snap-fit Front Cover Plate from the monitoring screen.
2. Use the monitoring screen as a template to mark the screw holes and trace the cut-out area on the mounting surface with a pencil.
3. Cut out a rectangle area for the monitoring screen on the mounting surface with a jigsaw. You may also use the cut out dimension specified after Step 2.
4. Pre-drill four screw holes on the mounting surface with a drill.
5. Put the monitoring screen into the cut-out area and align the mounting holes on the monitoring screen with the pre-drilled screw holes.
6. Fix the monitoring screen on the mounting surface with the included four self-tapping screws.
7. Re-attach the snap-fit Front Cover Plate to the monitoring screen.

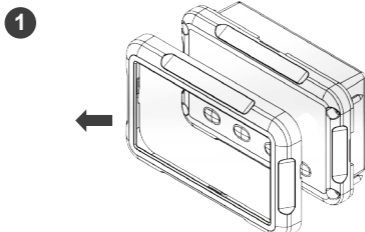

2

Cutout Dimensions
(L x H x W):
86.7 x 58.02 x 19.8mm

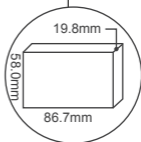
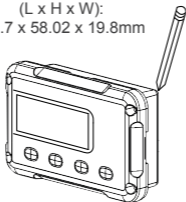

3

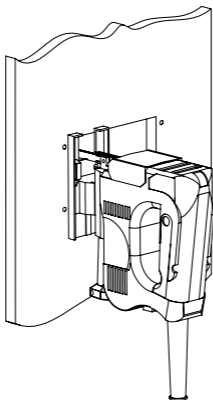

4

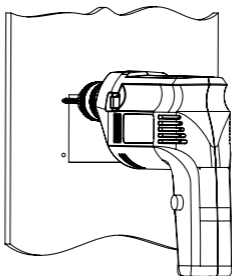

5

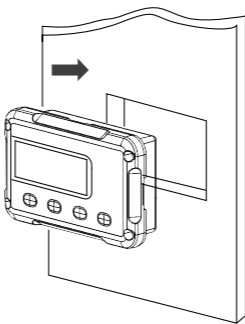

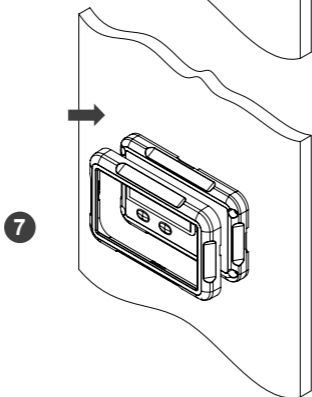
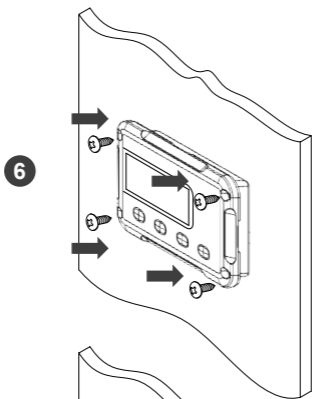

■ Connecting to the Charge Controller

Please connect the monitoring screen to the RS485 Port of the Rover Elite using the included RJ45 Communication Cable.

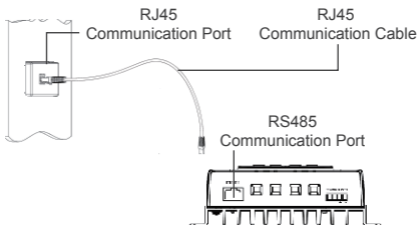

Operation

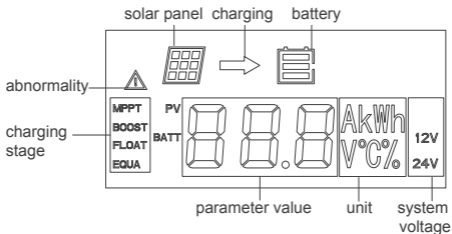

LCD interface:



NOTE

The RMS-RVRE is ONLY compatible with Rover Elite Series charge controllers.

 The following keys are used to navigate through system, PV, and battery information as well as identifying any error codes. Us the up and down keys to navigate through the monitoring screens.

  Enter parameter setting mode when highlighting the appropriate screen and pressing down on the rightmost key.

 Exit/Back when on parameter setting mode.



Once the monitoring screen is correctly connected the following screen will display with a delay of 6s before cycling through the normal display.

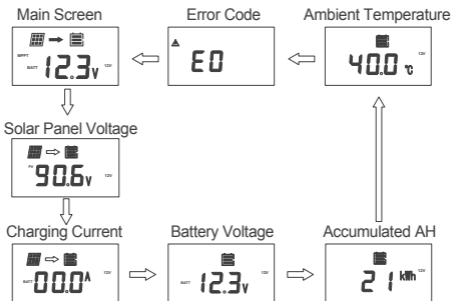

Navigating through Screens



LCD Indicators

Icon or Value	State	Description
	Steady on	Solar Panels Charging Battery
	3 Bars Flashing	Battery Voltage (16.1V+)
	3 Bars	Battery Voltage (12.9V- 16.0V)
	2 Bars	Battery Voltage (12.5-12.8V)
	1 Bar	Battery Voltage (11.6-12.4V)
	No Bars	Battery Voltage (11.5V and below)
	No Bars Flashing	Battery Voltage (10.9V and below)

Main Screen



Here you will find your general system information. You will see the charging state of the controller (MPPT, BOOST, FLOAT, EQUALIZATION), The battery voltage measured, the system voltage (12V or 24V) as well as the PV panel icon.

Please Note: The unit is charging when you see the arrow, not necessarily when you see the PV icon.

Solar Panel Voltage







Solar Panel voltage is displayed indicated by PV. The unit is charging if you see the arrow going towards the battery bank icon.

Charging Current



Battery charging current is displayed. Battery is charging if you see a value other than 0 and the arrow going towards the battery icon.

<p>Battery Voltage</p> 	<p>Battery Voltage is displayed indicated by Batt. System voltage is also displayed.</p>
<p>Accumulated AH</p> 	<p>Accumulated consumption is displayed. You may clear the contents back to 0 through the controller.</p>
<p>Ambient Temperature</p> 	<p>The temperature displayed is the controller's or the remote temperature sensor if utilizing the accessory. The unit is in Celsius and can not be changed to F on the interface.</p>
<p>Error Code</p> 	<p>The error code is displayed only if the unit experiences an error. If there is an error, it will be the default screen.</p>

Programming Battery Type

<p>WARNING</p>	<p>Incorrect battery type setting may damage your battery. Please check with your battery manufacturer's specifications before selecting the battery type.</p>
<p>NOTE</p>	<p>If selecting Lithium, Lithium refers to Lithium iron-phosphate and you will need to manually set the voltage to 12V or 24V as well as choose your charging voltage (14.4V Boost Voltage by default).</p>



Enter parameter setting mode when highlighting the appropriate screen and pressing down on the right key.

To enter battery programming settings, navigate to the Battery Voltage Screen (below) and then press and hold the right key button until the screen starts to flash the battery type:



Press and Hold

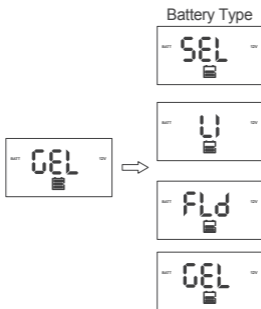

Utilize the arrows to navigate through Sealed Lead Acid / AGM (SEL), Lithium-Iron Phosphate (Li), Flooded (FLD) and Gel (Gel).



To confirm your selection, Press and Hold the right key. Please Note, when selecting Li, you will have to program your 12V or 24V manually.

Selecting Lithium

WARNING

Incorrect battery type setting may damage your battery. Please check with your battery manufacturer's specifications before selecting the battery type.

NOTE

If selecting Lithium, Lithium refers to Lithium iron-phosphate and you will need to manually set the voltage to 12V or 24V as well as choose your charging voltage (14.4V Boost Voltage by default).



Enter parameter setting mode when highlighting the appropriate screen and pressing down on the right key.

Set Li system Voltage:

To enter battery programming settings, navigate to the Battery Voltage Screen (below) and then press and hold the right key button until the screen starts to flash the battery type. Navigate the highlight Li and once LI is highlighted, tap the RIGHT button to set your system voltage. Choose between 12 or 24V and when satisfied, tap the RIGHT button to enter Boost Voltage Programming.



Press and Hold

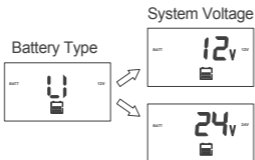

NOTE

Manual programming of 12V or 24V batteries is only available for Li batteries. For other battery types. The RMS-RVRE will recognize the Rover's Elite's auto recognition system voltage and adjust accordingly.

Set Li Boost Voltage

By default, the boost voltage will be 14.4V for Li. Once in the Boost Voltage screen, you can navigate in increments of 0.2V to set your appropriate boost voltage. Press the UP/DOWN arrows to change the boost voltage. You may select values between 12.6V ~ 16.0V.

To confirm your selection, Press and Hold the right key to confirm the parameters set.

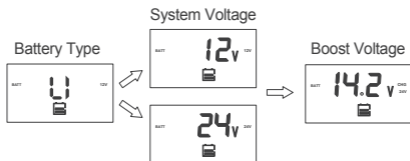

Lithium Battery Activation

The Rover Elite MPPT charge controller has a reactivation feature to awaken a sleeping lithium battery. The protection circuit of lithium battery will typically turn the battery off and make it unusable if over-discharged. This can happen when storing a lithium battery pack in a discharged state for any length of time as self-discharge would gradually deplete the remaining charge. Without the wake-up feature to reactivate and recharge batteries, these batteries would become unserviceable and the packs would be discarded. The Rover Elite will apply a small charge current to activate the protection circuit and if a correct cell voltage can be reached, it starts a normal charge. Lithium Battery Activation.

Troubleshooting

Error Codes / Troubleshooting

If the Rover Elite is not functioning properly, it will display an error code not normally seen in the interface display. Depending on the code, you may attempt to troubleshoot the error to commence normal system operation.

Error Code	Meaning	Troubleshoot
E0	No Error	System behaving normally, no action needed. You will not see this error code.
E01	Over-discharged battery	Use a multi-meter to get a reading of the battery voltage in volts DC to validate error code. Battery is very low. Disconnect any loads to the battery and let the solar system charge the battery backup. If the battery voltage is low it may be in open battery protection mode, which is a Rover Elite Protection.
E02	Battery Over-charging	Use a multi-meter to get a reading of the battery voltage in volts DC to validate error code. Battery is charging very high and approached 16VDC. Disconnect any external chargers and isolate which charger is overcharging battery. Eliminate from system.
E06	Controller internals over temperature	Make sure controller is in ventilated area and that the appropriate wire sizes are used to connect to and from the controller. This may be creating heating issues inside the controller. The controller will resume normal operation upon cooling down.

E07	Controller is over-temperature	Record the ambient temperature found in the controller screen. Make sure the controller is not placed in direct line of heating sources or that it is over-heating due to over-sun exposure. The controller will resume normal operation upon cooling down.
E10	PV Over-voltage	The controller has a maximum dc voltage input of 100DC. If connecting your panels in series, make sure the reading does not go over this limit. Check with a multi-meter before connecting to the controller to ensure you're within this specification. This might require using less panels.
E13	PV reverse-polarity	The solar panel wires are connected in reverse polarity. Verify using a multi-meter to make sure your voltage reading has the correct polarity with a positive number in volts DC.
E14	Battery reverse polarity	The battery cables are reversed. Use a multi-meter to make sure your voltage reading has the correct polarity (Red to positive and Black to negative) with a positive number in volts DC. If the number is negative, switch the positive and negative battery cables in the battery terminal of the Rover Elite.

Protection Behaviors / Fixes

If the Rover Elite is not functioning properly and is not displaying an error code, it may be undergoing an automatic protection function. This does not mean your Rover Elite is defective, but it requires some troubleshooting to commence normal system operation.

Behavior	Protective Function / Fixes
<p>The battery is connected to the controller, but the controller is not turning on</p>	<p>Reverse Battery Polarity Protection</p> <p>The Rover Elite needs a correct battery connection to startup. This might mean that the battery cables are reversed. Use a multi-meter to make sure your voltage reading has the correct polarity (Red to positive and Black to negative) with a positive number in volts DC. If the number is negative, switch the positive and negative battery cables in the battery terminal of the Rover Elite.</p>
<p>The battery and solar panels are connected to the controller, but the controller shows nighttime.</p>	<p>Solar Panels Reverse Polarity Protection</p> <p>The solar panel wires are connected in reverse polarity. Verify using a multi-meter to make sure your voltage reading has the correct polarity with a positive number in volts DC. In some cases, with the battery and solar panels both connected in reverse polarity, the controller will not turn on, but the controller is not damaged. Simply correct the reverse polarity to continue normal operation.</p>
<p>When connecting solar panels to the controller it sounds an alarm</p>	<p>Solar Panels Over voltage</p> <p>The controller has a maximum dc voltage input of 100DC. If connecting your panels in series, make sure the reading does not go over this limit. Check with a multi-meter before connecting to the controller to ensure you're within this specification. This might require using less panels to make sure you are within the Rover Elite specified input.</p>

<p>My system stopped charging</p>	<p>E02 Battery Overcharging</p> <p>If the battery was charging fine and stopped, it could be because it was being overcharged by the solar source if not an external source. You might see an E02 display or perhaps an empty screen. Make sure your charging sources are not charging at 16VDC or check to see if your batteries are being equalized, an intentional over-charging, that might be triggering this error.</p>
<p>Current Limiting / Temperature Protection</p>	<p>Current Limiting / E06 / E07</p> <p>The max amp charging from the Rover Elite will be the respective amp rating. The Rover Elite will current limit any excess amperage than the rating of the controller, however, be cautious as this might create excess heat and put the controller in an internal/external temperature protection mode which will halt the controller performance until it can cool down and function normally again.</p>
<p>The charge controller believes the battery is over-discharged, but it is not</p>	<p>Open Battery Protection Mode</p> <p>Whether connecting the system for the first time or operating it for a while, you may experience an E01 error if the controller does not actually detect a battery and assumes it to be under-discharged. This can happen in an accidental line break or failure to connect it correctly the first time. This will not damage the controller, but you will need to make sure the battery voltage is the same as the battery terminal voltage or check for continuity. Once fixed, normal operation should continue.</p>

Maintenance

For best controller performance, it is recommended that these tasks be performed from time to time.

1. Check wiring going into the charge controller and make sure there is no wire damage or wear.
2. Tighten all terminals and inspect any loose, broken, or burnt up connections.
3. Occasionally clean the case using a damp cloth.

Battery Charging Parameters

Battery	SLD/AGM	GEL	FLOODED	LI(LFP)
High Voltage Disconnect	16 V	16 V	16 V	16 V
Over Voltage Reconnect	15 V	15 V	15 V	15 V
Equalization Voltage	----	----	14.8V	----
Boost Charge Voltage	14.6 V	14.2 V	14.6 V	14.4V User: 12.6V-16V
Float Charge Voltage	13.8 V	13.8 V	13.8 V	----
Boost Return Voltage	13.2 V	13.2 V	13.2 V	13.2 V
Over-discharge Recover	12.6 V	12.6 V	12.6 V	12.6 V
Over-discharge Warning	11.1 V	11.1 V	11.1 V	11.1 V
Equalization Interval	----	----	30 Days	----
Equalization Duration	----	----	2 hours	----
Boost Duration	2 hours	2 hours	2 hours	----

This equipment has been tested and found to comply with the limits for a class B digital device, pursuant to part 15 of the FCC Rules. These limits are designed to provide reasonable protection against harmful interference in a residential installation. This equipment generates, uses and can radiate radio frequency energy and if not installed and used in accordance with the instructions, may cause harmful interference to radio communications. However, there is no guarantee that interference will not occur in a particular installation. If this equipment does cause harmful interference to radio or television reception, which can be determined by turning the equipment off and on, the user is encouraged to try to correct the interference by one or more of the following measures:

- Reorient or relocate the receiving antenna.
- Increase the separation between the equipment and receiver.
- Connect the equipment into an outlet on a circuit different from that to which the receiver is connected.
- Consult the dealer or an experienced radio/TV technician for help.

This device complies with Part 15 of the FCC Rules.

Operation is subject to the following two conditions:

- (1) this device may not cause harmful interference, and
- (2) this device must accept any interference received, including interference that may cause undesired operation.

Renogy reserves the right to change the contents of this manual without notice.

US | 📍 2775 E Philadelphia St, Ontario, CA 91761, USA
☎ 909-287-7111
🌐 www.renogy.com
✉ support@renogy.com

CN | 📍 苏州高新区科技城培源路1号5号楼-4
☎ 400-6636-695
🌐 <https://www.renogy.cn>
✉ support@renogy.cn

JP | 🌐 <https://www.renogy.jp>
✉ supportjp@renogy.com

CA | 🌐 <https://ca.renogy.com>
✉ supportca@renogy.com

AU | 🌐 <https://au.renogy.com>
✉ supportau@renogy.com

UK | 🌐 <https://uk.renogy.com>
✉ supportuk@renogy.com

DE | 🌐 <https://de.renogy.com>
✉ supportde@renogy.com